

app. proj. 1"

15

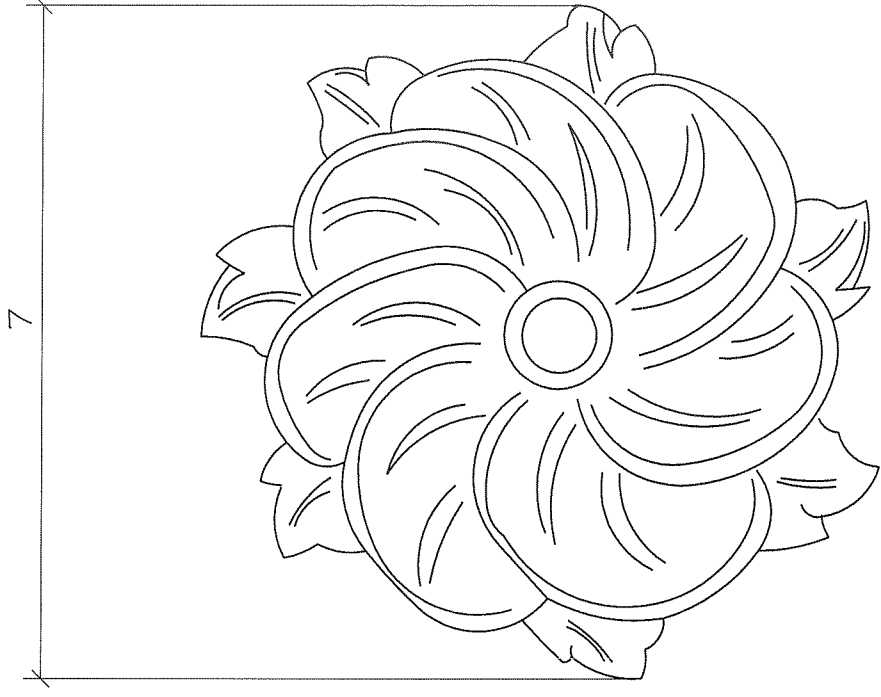

app. proj. 1- $\frac{1}{2}$ "

61-L / 61-R

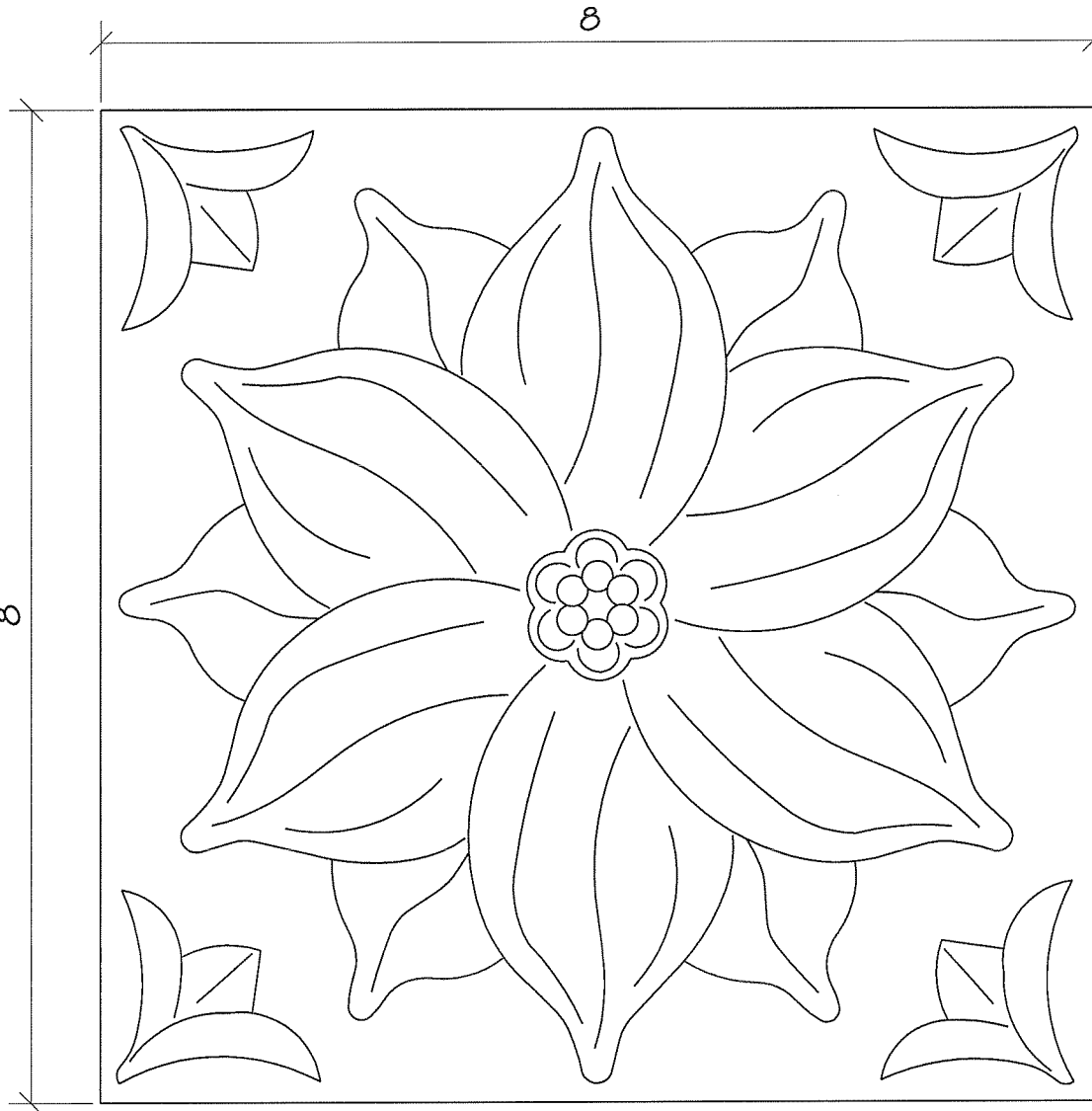

app. proj. $\frac{3}{4}$ "

225

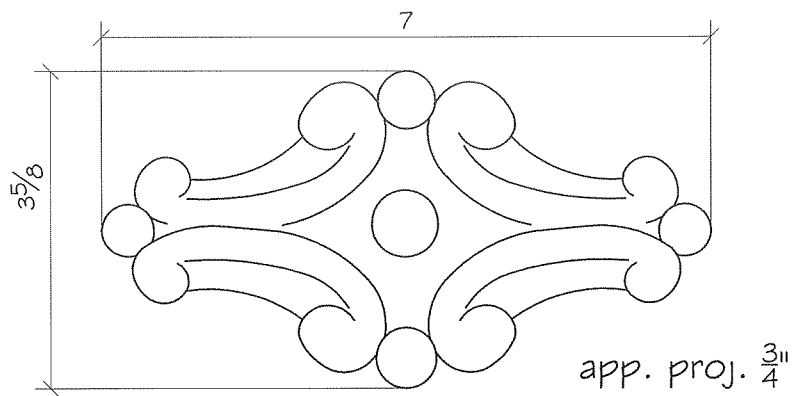

213

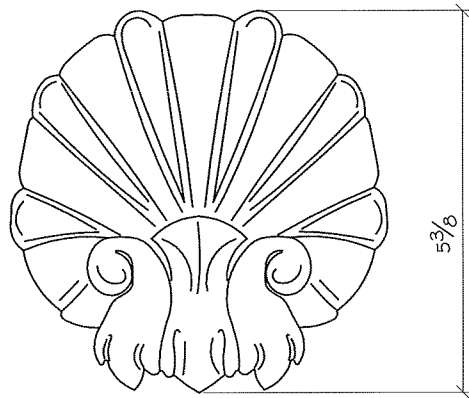

241

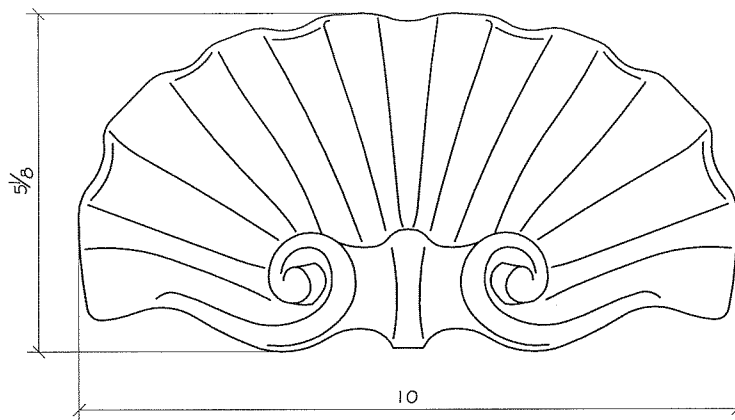

242

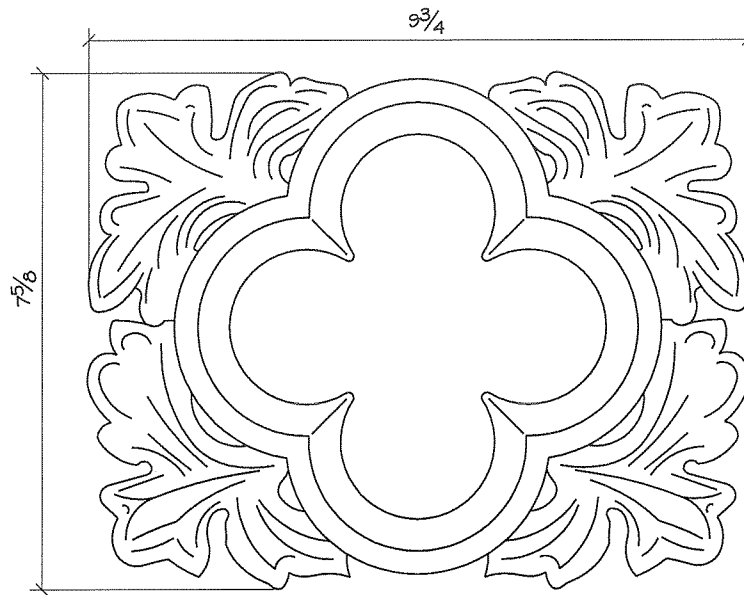

app. proj. $\frac{3}{4}$ "

246

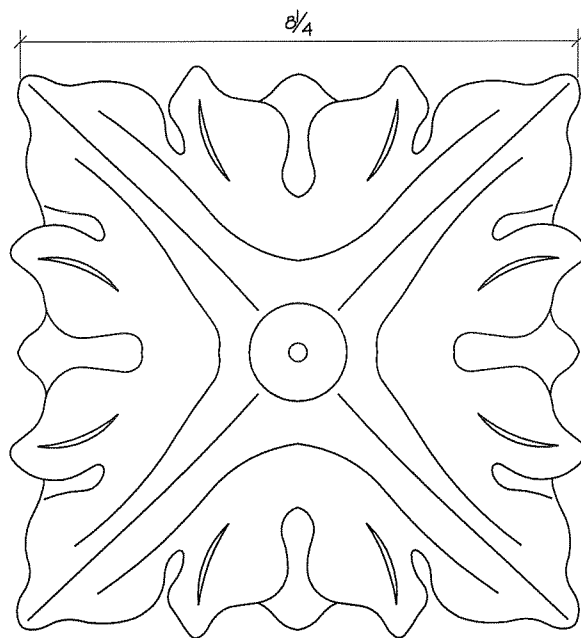

app. proj. $\frac{1}{2}$ "

247

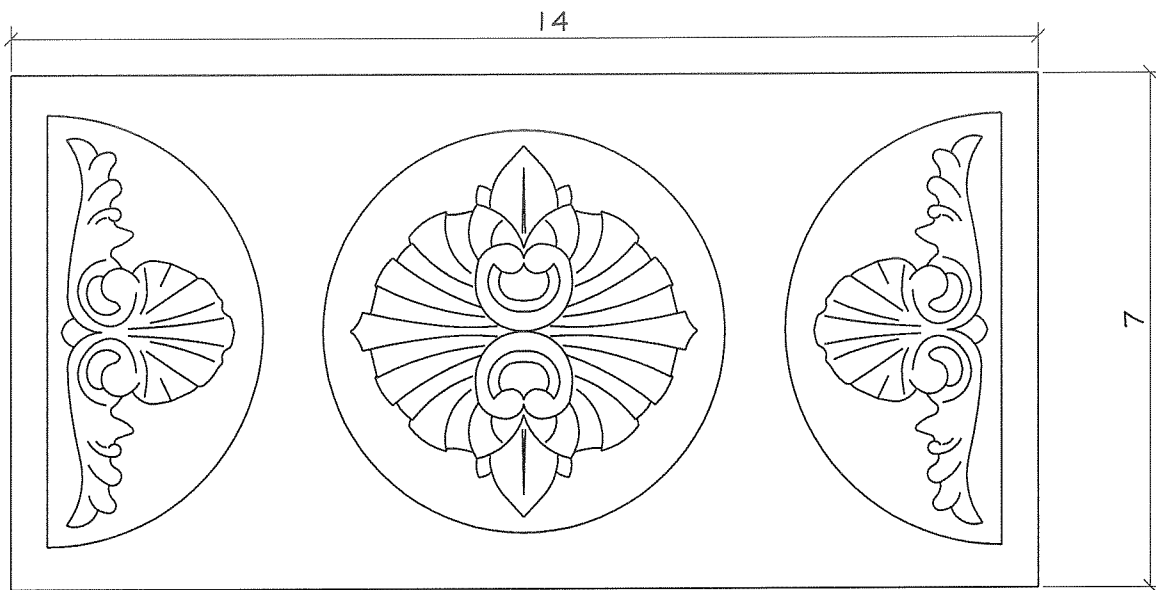

carving inset
into $\frac{1}{2}$ " material

256

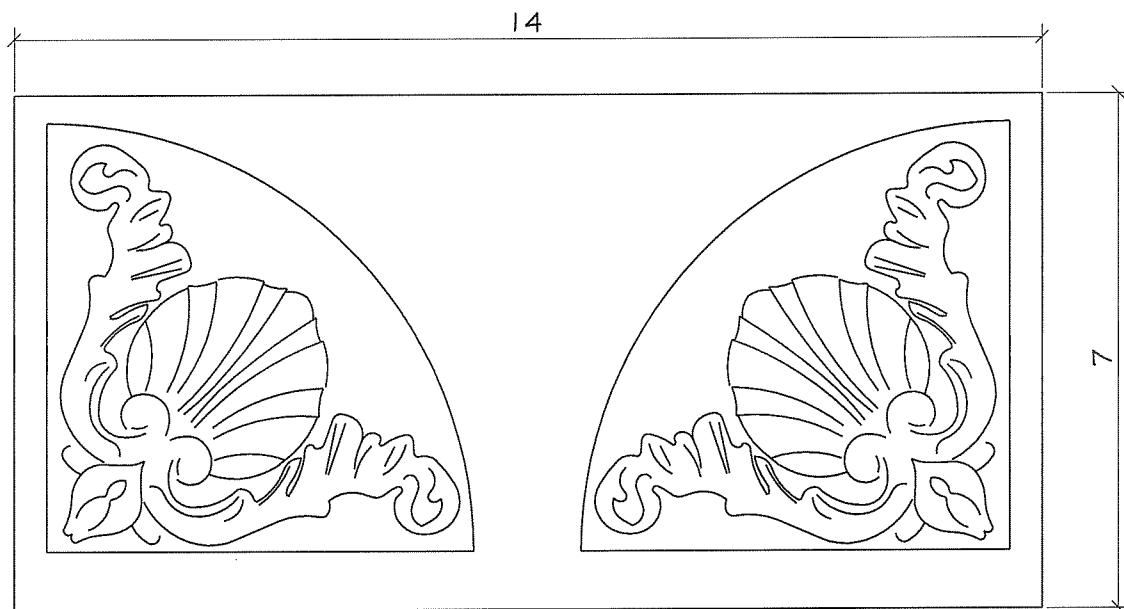

carving inset
into $\frac{1}{2}$ " material

257

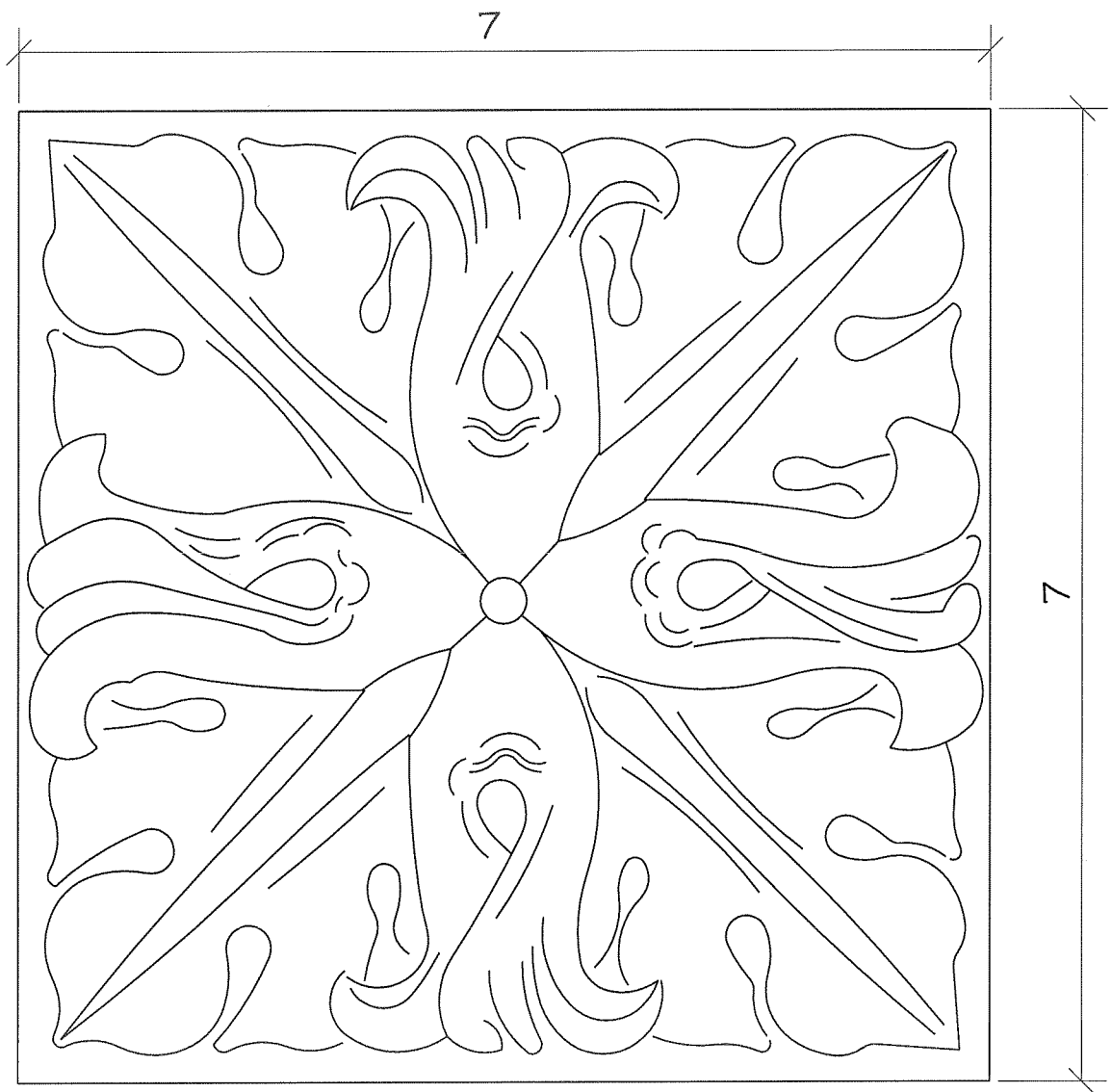

app. proj. $\frac{3}{4}$ "

259

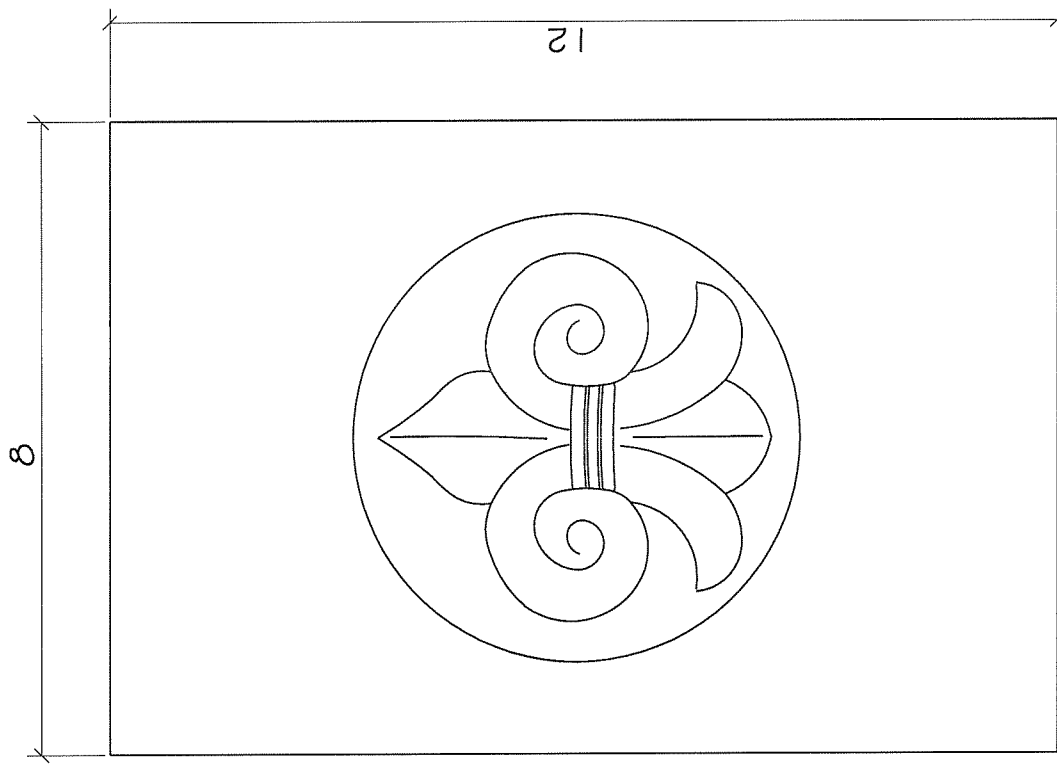

inset into
 $\frac{3}{4}$ " material

278

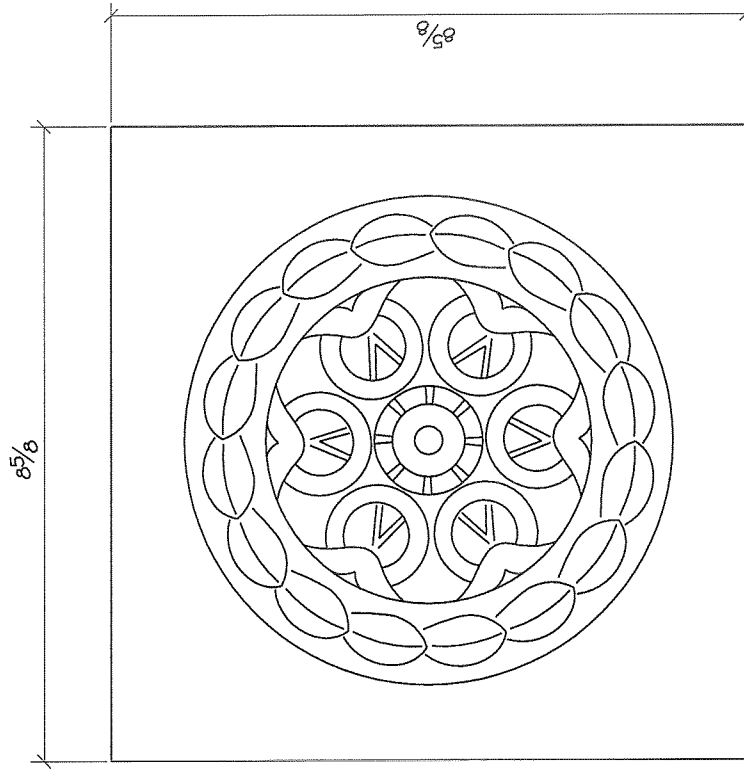

app. proj. $\frac{3}{4}$ "

277

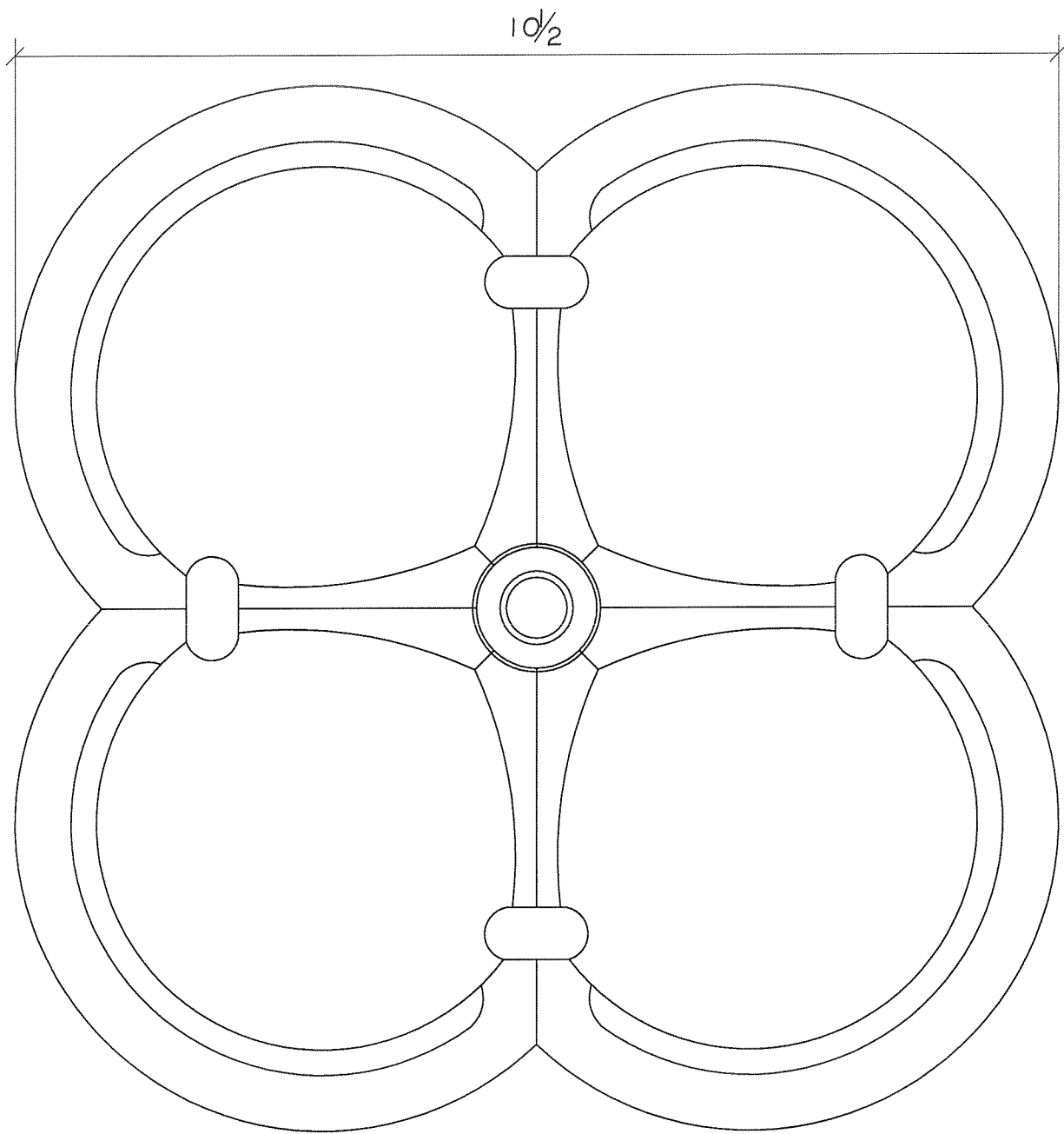

app. proj. $\frac{3}{4}$ "

290

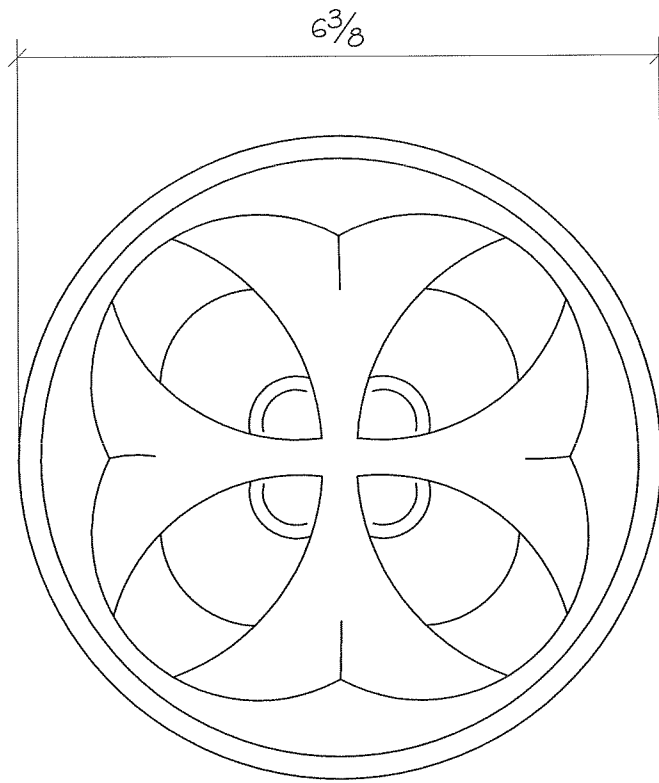

app. proj. $\frac{3}{4}$ "

339